

Data Sheet



Article number: 025799200088

Description: Norma Connect pipe coupling
GRIP E W4 Ø=88,9 EPDM, 16 bar

Measures

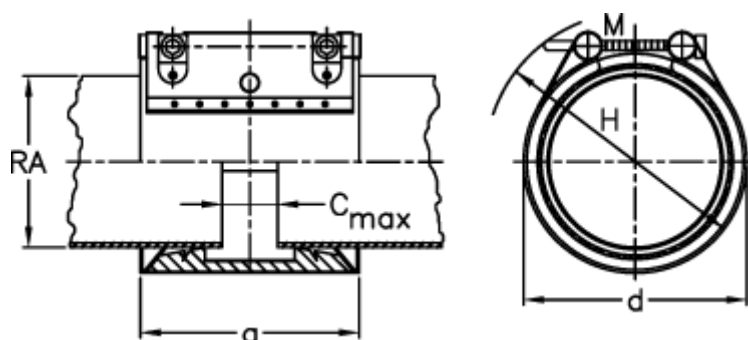

a	= 98
C max with insertion band	= 25
d	= 120
H	= 145
M (screw)	= M10
Nominal pressure (bar)	= 16
RA	= 88.9
RA min-RA max	= 96,9-99,0

Weight a piece = 1.6